

Conductive Level Controller

K8AK-LS

Ideal for Liquid Level Control in Industrial Facilities and Equipment.

- Self-holding circuit implemented with circuit processing that is not depending on external wiring.
- Switch between water supply and discharge with a DIP switch setting.
- Sensitivity adjustment of operating resistance from 10 k to 100 kΩ for application to a wide range of liquids.
- Prevents chattering of relay contacts that occurs with ripples.
- Easy wiring with ferrules.
- Use 2 × 2.5 mm² solid wire or 2 × 1.5 mm² ferrules.
- Applicable as a floatless switch.



For the most recent information on models that have been certified for safety standards, refer to your OMRON website.

Refer to *Safety Precautions* on page 7.

Ordering Information

Power supply voltage	Model
24 VAC/DC	K8AK-LS1 24 VAC/DC
100 to 240 VAC	K8AK-LS1 100-240 VAC

Accessories (Order Separately)

● Electrode Holders/Underwater Electrodes

Application	For general-purpose use, such as water supply lines	For areas with limited space	For liquids with low resistance	When mounting strength is required	For resistance to high-temperature or high-pressure liquids	For resistance against corrosion	For installation at long distances from the liquid level
Model	PS-3S/-4S/-5S	PS-31 SUS304, 300 mm	BF-1	BF-3/-5	BS-1	BS-1T	PH-1/-2
Appearance							

● Electrode Rods

Electrode Rods are available in sets with the connection nuts, lock nuts, and tightening screws.



Application	Purified water service, industrial water, and sewage	Purified water service, industrial water, sewage, and weak alkaline solutions
Model	F03-60 SUS304	F03-60 SUS316

● Others

Item	Model
Protective Cover (Electrode Holders for the PS or BF Series)	F03-11
Mounting Piece (Electrode Holder for the PS Series)	F03-12
Separator (to prevent contact between electrodes)	F03-14 1P (one pole) F03-14 3P (three poles) F03-14 5P (five poles)

K8AK-LS

Ratings and Specifications

Ratings

Power supply voltage	24 VAC 50/60 Hz or 24 VDC 100 to 240 VAC 50/60 Hz
Voltage across electrodes	5 V p-p (Approx. 20 Hz)
Power consumption	24 VAC/DC: 2.0 VA/1.1 W max. 100 to 240 VAC: 4.6 VA max.
Operating resistance	10 k to 100 kΩ (variable)
Reset resistance	250 kΩ max.
Response time	Approx. 0.1 to 10 s (variable)
Length of cable	100 m max. (fully insulated 3-core 0.75-mm ² cable, 600 V)
Indicators	PWR: Green, RY: Yellow
Output contact ratings	Rated load Resistive load 5 A at 250 VAC 5 A at 30 VDC Maximum switching capacity: 1,250 VA, 150 W Minimum load: 5 VDC, 10 mA (reference values) Mechanical life: 10 million operations min. Electrical life: 5 A at 250 VAC or 30 VDC: 50,000 operations 3 A at 250 VAC/30 VDC: 100,000 operations
Ambient operating temperature	-20 to 60°C (with no condensation or icing)
Storage temperature	-25 to 65°C (with no condensation or icing)
Ambient humidity	25% to 85% (with no condensation)
Storage humidity	25% to 85% (with no condensation)
Altitude	2,000 m max.
Terminal screw tightening torque	0.49 to 0.59 N·m
Case color	N1.5
Case material	PC and ABS, UL 94 V-0
Weight	Approx. 150 g
Mounting	Mounts to DIN Track.
Dimensions	22.5 × 90 × 100 mm (W×D×H)

Specifications

Operating voltage range	85% to 110% of rated voltage
Installation environment	Installation category II, pollution level 2
Approved standards	EN 61010-1
EMC	EN 61326-1 Industrial electromagnetic environment
Safety standards	UL 508 (Recognition), Korean Radio Waves Act (Act 10564), CSA: C22.2 No.14, CCC: GB/T 14048.5
Insulation resistance	20 MΩ min. Between all external terminals and the case Between all power supply terminals and all input terminals Between all power supply terminals and all output terminals Between all input terminals and all output terminals
Dielectric strength	2,000 VAC for 1 min Between all external terminals and the case Between all power supply terminals and all input terminals Between all power supply terminals and all output terminals Between all input terminals and all output terminals
Noise immunity	1,500 V power supply terminal common/normal mode Square-wave noise of ±1-μs/100-ns pulse width with 1-ns rise time
Vibration resistance	Frequency: 10 to 55 Hz, 0.35-mm single amplitude 10 sweeps of 5 min each in X, Y, and Z directions
Shock resistance	100 m/s ² , 3 times each in 6 directions along 3 axes
Degree of protection	Terminals: IP20

Connections

Terminal Diagram

K8AK-LS1 100-240VAC

① ②

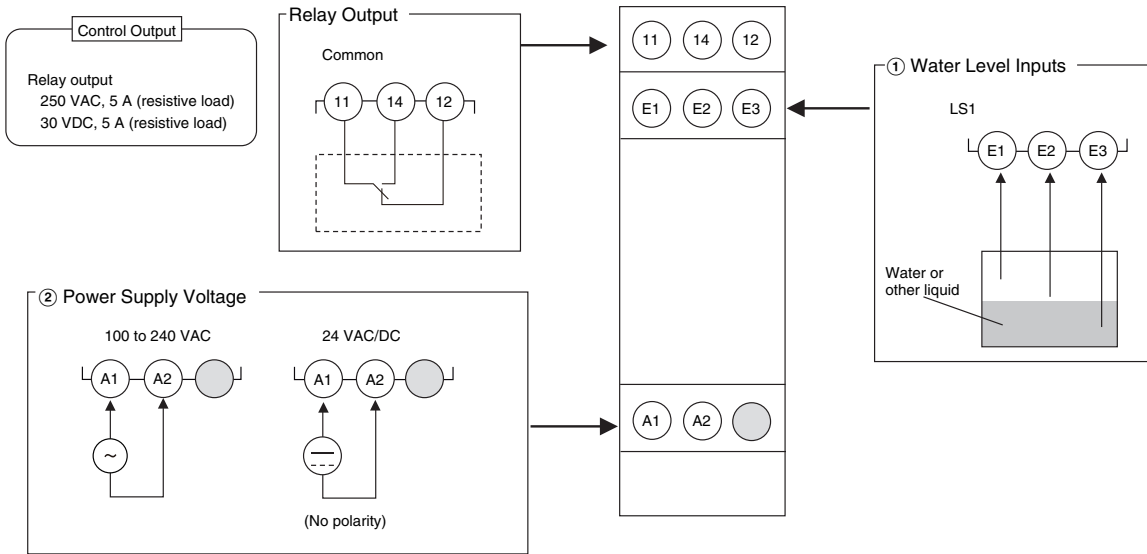

Note: 1. Do not connect anything to terminals that are shaded in gray.
 2. Use the recommended ferrules if you use twisted wires.

Wiring Example

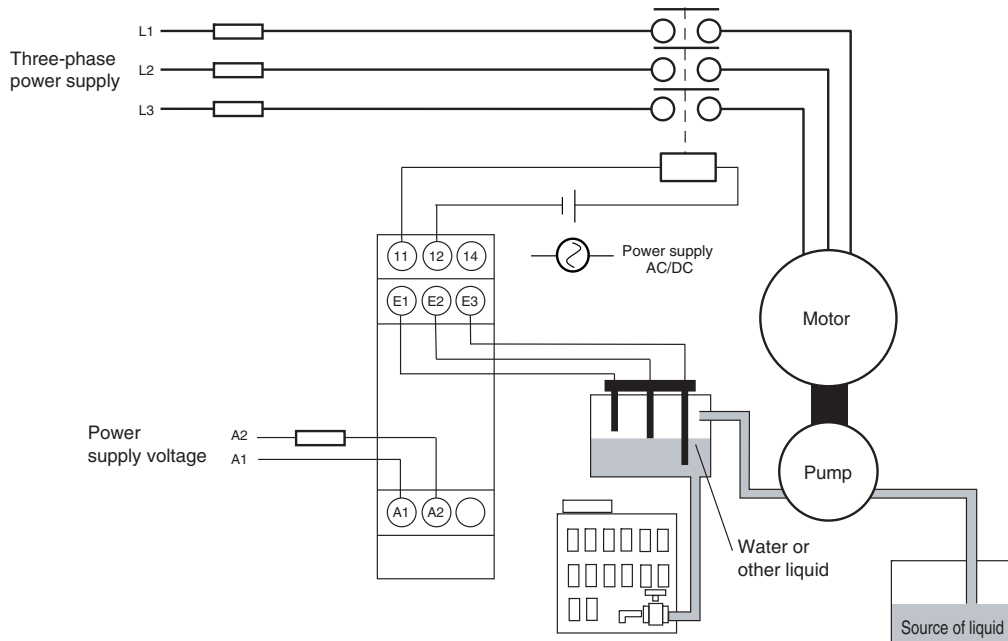

Pump motor protection mechanisms have been omitted.

Timing Charts

●DIP Switch Pin 1: OFF (Automatic Liquid Supply Operation)

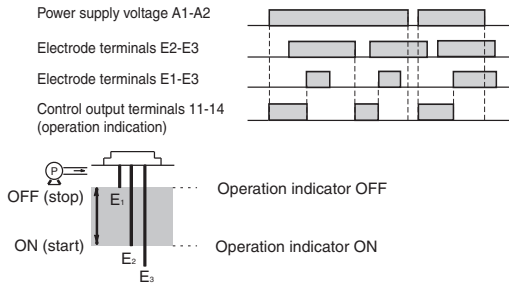

- When the liquid level falls to E2 (indicator turns ON), the pump starts.
When the liquid level rises above E1 (indicator turns OFF), the pump stops.

●DIP Switch Pin 1: ON (Automatic Liquid Discharge Operation)

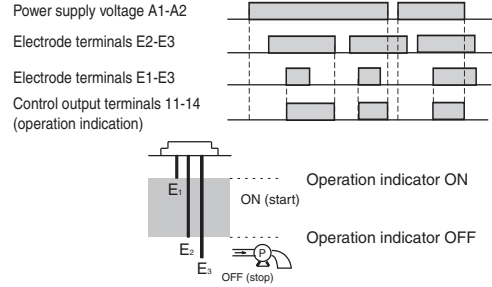

- When the liquid level reaches E1 (indicator turns ON), the pump starts.
When the liquid level falls below E2 (indicator turns OFF), the pump stops.

Nomenclature

Front Panel

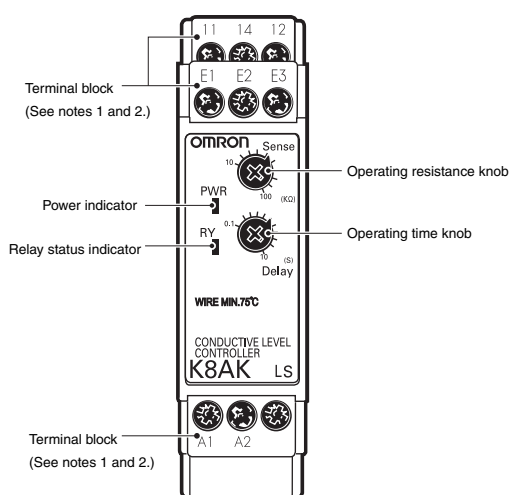

●Indicators

Item	Description
Power indicator (PWR: Green)	Lit when power is being supplied.
Relay status indicator (RY: Yellow)	Lit when contacts are operating.

●Setting Knobs

Item	Description
Operating resistance knob	Used to set the resistance to 10 to 100 kΩ.
Operating time knob	Used to set the operating time to 0.1 to 10 s.

Note: 1. Use solid-core wires of 2.5-mm² max. or ferrules with an insulation sleeve to wire to this terminal. To ensure the dielectric strength of the connection, do not expose more than 8 mm of wire for insertion into the terminal.

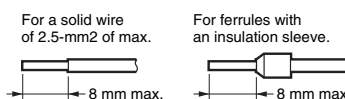

Recommended ferrules
Phoenix Contact

- AI 1,5-8BK (for AWG16)
- AI 1-8RD (for AWG18)
- AI 0,75-8GY (for AWG18)

2. Screw tightening torque: 0.49 to 0.59 N·m

Operation Method

DIP Switch Settings

The operating mode is set using the DIP switch located at the bottom of the Unit. The K8AK-LS does not have SW2.

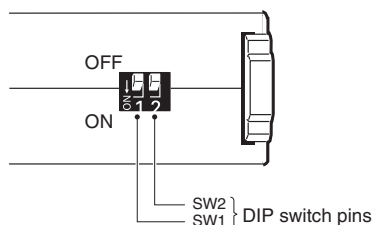

●DIP Switch Function

Pin		OFF ● ↑	ON ○ ↓
		OFF 1	ON 2
Operating mode	Automatic liquid supply operation	●	○
	Automatic liquid discharge operation	○	●
			Not used.

Note: All pins are set to OFF by default.

K8AK-LS

Dimensions

(Unit: mm)

Conductive Level Controller

K8AK-LS

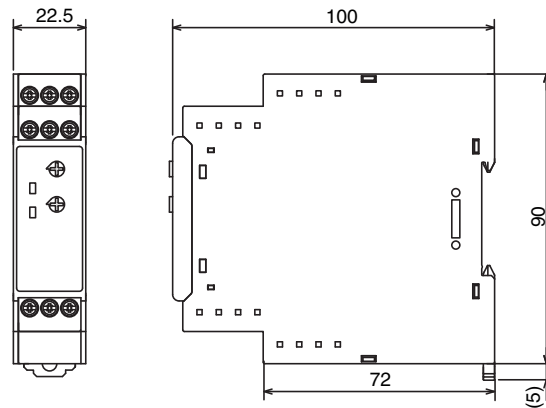

Optional Parts for DIN Track Mounting

●DIN Tracks

PFP-100N

PFP-50N

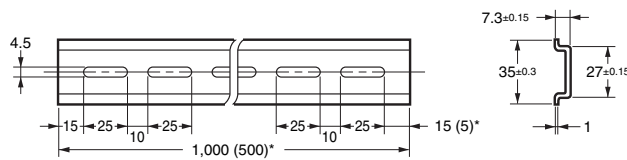
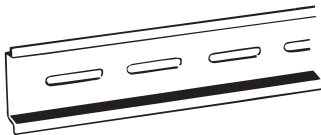

*Dimensions in parentheses are for the PFP-50N.





Safety Precautions

Be sure to read the precautions for all models in the website at the following URL: <http://www.ia.omron.com/>.

Warning Indications

 CAUTION	Indicates a potentially hazardous situation which, if not avoided, may result in minor or moderate injury or in property damage.
Precautions for Safe Use	Supplementary comments on what to do or avoid doing, to use the product safely.
Precautions for Correct Use	Supplementary comments on what to do or avoid doing, to prevent failure to operate, malfunction, or undesirable effects on product performance.

Meaning of Product Safety Symbols

	Used to warn of the risk of electric shock under specific conditions.
	Used for general prohibitions for which there is no specific symbol.
	Used to indicate prohibition when there is a risk of minor injury from electrical shock or other source if the product is disassembled.
	Used for general mandatory action precautions for which there is no specified symbol.

CAUTION

Electrical shock may cause minor injury.
Do not touch terminals while electricity is being supplied.



There is a risk of minor electrical shock, fire, or device failure.
Do not allow any pieces of metal, conductors, or cutting chips that occur during the installation process to enter the product.



Explosions may cause minor injuries. Do not use the product in locations with inflammable or explosive gases.

There is a risk of minor electrical shock, fire, or device failure.
Do not disassemble, modify, repair, or touch the inside of the product.



Loose screws may cause fires. Tighten terminal screws to the specified torque of 0.49 to 0.59 N·m.



Use of excessive torque may damage the terminal screws.
Tighten terminal screws to the specified torque of 0.49 to 0.59 N·m.



Use of the product beyond its life may result in contact welding or burning. Make sure to consider the actual operating conditions and use the product within its rated load and electrical life count. The life of the output relay varies significantly with the switching capacity and switching conditions.



Precautions for Safe Use

1. Do not use or store the product in the following locations.
 - Locations subject to water or oil
 - Outdoor locations or under direct sunlight
 - Locations subject to dust or corrosive gases (particularly sulfurizing gases, ammonia, etc.)
 - Locations subject to rapid temperature changes
 - Locations prone to icing and dew condensation
 - Locations subject to excessive vibration or shock
 - Locations subject to wind and rain
 - Locations subject to static electricity and noise
 - Habitats of insects or small animals
2. Use and store the product in a location where the ambient temperature and humidity are within the specified ranges. If applicable, provide forced cooling.
3. Mount the product in the correct direction.
4. Check terminal polarity when wiring and wire all connections correctly. The power supply terminals do not have polarity.
5. Do not wire the input and output terminals incorrectly.
6. Make sure the power supply voltage and loads are within the specifications and ratings for the product.
7. Make sure the crimp terminals for wiring are of the specified size.
8. Do not connect anything to terminals that are not being used.
9. Use a power supply that will reach the rated voltage within 1 second after the power is turned ON.
10. Keep wiring separate from high voltages and power lines that draw large currents.
Do not place product wiring in parallel with or in the same path as high-voltage or high-current lines.
11. Do not install the product near equipment that generates high frequencies or surges.
12. The product may cause incoming radio wave interference. Do not use the product near radio wave receivers.
13. Install an external switch or circuit breaker and label it clearly so that the operator can quickly turn OFF the power supply.
14. Make sure the indicators operate correctly. Depending on the application environment, the indicators may deteriorate prematurely and become difficult to see.
15. The terminal blocks may heat up to 65°C. Use care when handling them.
16. Do not use the product if it is accidentally dropped. The internal components may be damaged.
17. Be sure you understand the contents of this catalog and handle the product according to the instructions provided.
18. Do not install the product in any way that would place a load on it.
19. When discarding the product, properly dispose of it as industrial waste.
20. When using the product, remember that the power supply terminals carry a high voltage.
21. The product must be handled only by trained electrician.
22. Prior to operation, check the wiring before you supply power to the product.
23. Do not install the product immediately next to heat sources.
24. Perform periodic maintenance.

Precautions for Correct Use

Observe the following operating methods to prevent failure and malfunction.

1. Use the power supply voltage, input power, and other power supplies and converters with suitable capacities and rated outputs.
2. Use a precision screwdriver or similar tool to adjust the setting knobs.
3. When cleaning the product, do not use thinners or solvents. Use commercial alcohol.

Correct Mounting Direction, Mounting, and Removing

• Mounting to DIN Track

1. Attach the product to the DIN Track with the tab at the top and the hooks at the bottom.
2. Push the product onto the Track until the hooks lock into place.

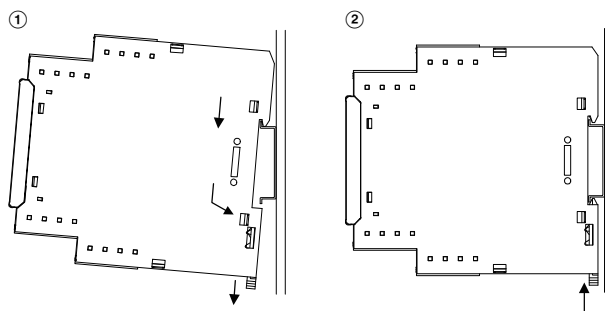

• Removing from the DIN Track

- Pull down on the bottom hook with a flat-blade screwdriver and lift up on the product.

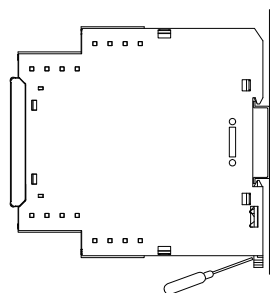

Applicable DIN Tracks:
 PFP-100N (100 cm)
 PFP-50N (50 cm)

Adjusting the Setting Knobs

- Use a screwdriver to adjust the setting knobs. The knobs have a stopper that prevents them from turning beyond the full right or left position. Do not force a knob beyond these points.

